

Weld Fittings

M Series



L Series



T Series



Fittings

Valves

Pressure Gauges

Integrated Systems and Others

Process Specification

Weld Fittings

Features

- ⦿ Radius junction design with elbows to provide smooth flow path
- ⦿ Precision machined diameter to match tube diameter
- ⦿ Square, burr-free tube weld ends to enhance alignment
- ⦿ Manual or automatic welding equipment applicable
- ⦿ Tube wall uniformity to promote weld repeatability
- ⦿ M and L series standard surface roughness finished to an average of Ra 10 μm . (0.25 μm) or electropolished to Ra 5 μm . (0.13 μm) optional.
T series standard surface roughness finished to an average of Ra 15 μm . (0.38 μm) or electropolished to Ra 10 μm . (0.25 μm) optional.
- ⦿ Each fitting marked with brand, material and heat number

Technical Data

- ⦿ Materials:

Material	Bar Stock ^①	Forging ^②	Designator
316 SS	ASTM A479	ASTM A182	SS
316L SS	SEMI F20	SEMI F20	6L
316L VAR SS			6LV
316L VIM-VAR SS			6LW

① Only for straight configurations and all M Series weld fittings.

② Includes all elbows, crosses and tees, excluding M series and T series fittings.

- ⦿ Working Pressure:

- a. Working pressures shown in the Catalog are calculated according to ASME B31.3 and B31.1 at ambient temperature.
- b. To get the allowable working pressure at elevated temperature, use the allowable working pressure at ambient temperature to multiply the elevated temperature factors. Please refer to Table 22 - Elevated Temperature Factors in the FITOK Catalog **Tubing** for the elevated temperature factors.

- ⦿ Weld End Tube O.D. and Wall Thickness

Fractional		Metric	
Tube O.D. in.	Wall Thickness in.	Tube O.D. mm	Wall Thickness mm
1/8	0.028	6	1.0
1/4	0.035	8	1.0
3/8	0.035	10	1.0
1/2	0.049	12	1.0
3/4	0.049/0.065	18	1.5
1	0.065		
1 1/2	0.065		
2	0.065		

For other sizes or wall thicknesses of welded ports, please contact FITOK Group or our authorized distributors.

③ O.D. 3/4" x wall Thickness 0.065" tubing is for T Series tubular fittings.

- ⦿ Working Temperature:

Material	Minimum Temperature	Maximum Temperature
316 SS	-325 °F (-198 °C)	1000 °F (538 °C)
316L SS		
316L VAR SS		
316L VIM-VAR SS		

Ordering Information

- ⦿ Add the material designator as a prefix, process specification as a suffix to the basic ordering number to get the complete ordering number.
 - ⦿ Cleaning and Packaging
 - a. FC-01 Standard Cleaning and Packaging. No suffix is needed.
 - b. FC-02 Special Cleaning and Packaging. Add "-F2" as a suffix when needed.
 - c. FC-03 Ultra High Purity Process Specification. Add "-F3" as a suffix when needed.
- Example: For 1/2" 316L VAR SS Union Tee with FC-03 Ultra High Purity Process Specification, the ordering number is 6LV-WT1-TB8-F3.

Cautions

- ⦿ Dimensions are for reference only and are subject to change.
- ⦿ Welding of the same material is more advisable considering the same coefficient of expansion, lower possibility of poor weld such as out-of-roundness or dimensional changes.

M Series Micro Weld Fittings

Features

- ⦿ Compact design
- ⦿ Sizes range from 1/8" to 1/2" and 6 mm to 12 mm
- ⦿ Applicable to miniaturized tubing system



Reducing Unions

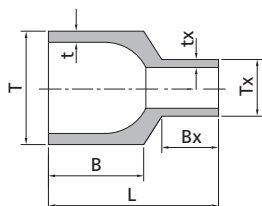

Fractional								
T-Tube O.D. (in.)	t-Wall Thickness (in.)	Tx-Tube O.D. (in.)	tx-Wall Thickness (in.)	Basic Ordering Number	Dimensions, in. (mm)			Working Pressure psig (bar)
					L	B	Bx	
1/4	0.035	1/8	0.028	-WU1-TB4-TB2	0.75 (19.1)	0.42 (10.7)	0.25 (6.4)	5100 (351)
3/8	0.035	1/4	0.035	-WU1-TB6-TB4	0.75 (19.1)	0.42 (10.7)	0.25 (6.4)	3300 (227)
1/2	0.049	1/4	0.035	-WU1-TB8-TB4	0.75 (19.1)	0.42 (10.7)	0.25 (6.4)	3700 (254)
1/2	0.049	3/8	0.035	-WU1-TB8-TB6	0.75 (19.1)	0.42 (10.7)	0.25 (6.4)	3300 (227)

90° Union Elbows

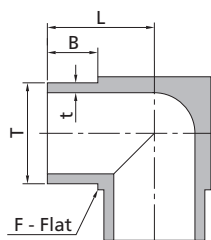

Fractional						
T-Tube O.D. (in.)	t-Wall Thickness (in.)	Basic Ordering Number	Dimensions, in. (mm)			Working Pressure psig (bar)
			L	B	F	
1/8	0.028	-WL1-TB2	0.41 (10.4)	0.25 (6.4)	5/16 (7.9)	8500 (585)
1/4	0.035	-WL1-TB4	0.41 (10.3)	0.25 (6.4)	5/16 (7.9)	5100 (351)
3/8	0.035	-WL1-TB6	0.47 (11.9)	0.25 (6.4)	7/16 (11.1)	3300 (227)
1/2	0.049	-WL1-TB8	0.53 (13.5)	0.25 (6.4)	9/16 (14.3)	3700 (254)

Metric						
T-Tube O.D. (mm)	t-Wall Thickness (mm)	Basic Ordering Number	Dimensions, mm (in.)			Working Pressure bar (psig)
			L	B	F	
6	1.0	-WL1-MTB6	10.4 (0.41)	6.4 (0.25)	7.9 (5/16)	420 (6095)
8	1.0	-WL1-MTB8	11.9 (0.47)	6.4 (0.25)	11.1 (7/16)	310 (4499)
10	1.0	-WL1-MTB10	11.9 (0.47)	6.4 (0.25)	11.1 (7/16)	240 (3483)
12	1.0	-WL1-MTB12	13.5 (0.53)	6.4 (0.25)	14.3 (9/16)	200 (2902)

Extended Leg 90° Union Elbows

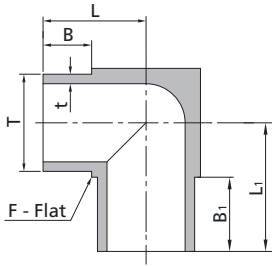

Fractional								
T-Tube O.D. (in.)	t-Wall Thickness (in.)	Basic Ordering Number	Dimensions, in. (mm)					Working Pressure psig (bar)
			B	B ₁	F	L	L ₁	
1/4	0.035	-WL1-TB4-1	0.25 (6.4)	0.45 (11.4)	5/16 (7.9)	0.41 (10.4)	0.61 (15.5)	5100 (351)
1/4	0.035	-WL1-TB4-2	0.25 (6.4)	0.50 (12.7)	5/16 (7.9)	0.41 (10.4)	0.66 (16.8)	5100 (351)
1/4	0.035	-WL1-TB4-3	0.45 (11.4)	0.45 (11.4)	5/16 (7.9)	0.61 (15.5)	0.61 (15.5)	5100 (351)
1/4	0.035	-WL1-TB4-4	0.50 (12.7)	0.50 (12.7)	5/16 (7.9)	0.66 (16.8)	0.66 (16.8)	5100 (351)

Reducing 90° Union Elbows

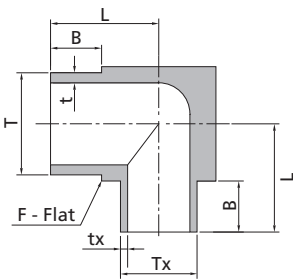

Fractional								
T-Tube O.D. (in.)	t-Wall Thickness (in.)	Tx-Tube O.D. (in.)	tx-Wall Thickness (in.)	Basic Ordering Number	Dimensions, in. (mm)			Working Pressure psig (bar)
					L	B	F	
3/8	0.035	1/4	0.035	-WL1-TB6-TB4	0.47 (11.9)	0.25 (6.4)	7/16 (11.1)	3300 (227)
1/2	0.049	1/4	0.035	-WL1-TB8-TB4	0.53 (13.5)	0.25 (6.4)	9/16 (14.3)	3700 (254)
1/2	0.049	3/8	0.035	-WL1-TB8-TB6	0.53 (13.5)	0.25 (6.4)	9/16 (14.3)	3300 (227)

Metric								
T-Tube O.D. (mm)	t-Wall Thickness (mm)	Tx-Tube O.D. (mm)	tx-Wall Thickness (mm)	Basic Ordering Number	Dimensions, mm (in.)			Working Pressure bar (psig)
					L	B	F	
8	1.0	6	1.0	-WL1-MTB8-MTB6	11.9 (0.47)	6.4 (0.25)	11.1 (7/16)	310 (4499)
10	1.0	6	1.0	-WL1-MTB10-MTB6	11.9 (0.47)	6.4 (0.25)	11.1 (7/16)	240 (3483)
12	1.0	6	1.0	-WL1-MTB12-MTB6	13.5 (0.53)	6.4 (0.25)	14.3 (9/16)	200 (2902)
12	1.0	8	1.0	-WL1-MTB12-MTB8	13.5 (0.53)	6.4 (0.25)	14.3 (9/16)	200 (2902)

45° Union Elbows

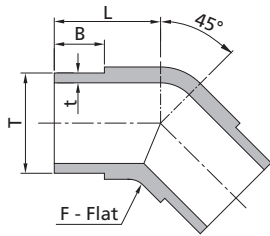

Fractional						
T-Tube O.D. (in.)	t-Wall Thickness (in.)	Basic Ordering Number	Dimensions, in. (mm)			Working Pressure psig (bar)
			L	B	F	
1/4	0.035	-WV1-TB4	0.41 (10.4)	0.25 (6.4)	5/16 (7.9)	5100 (351)
3/8	0.035	-WV1-TB6	0.47 (11.9)	0.25 (6.4)	7/16 (11.1)	3300 (227)
1/2	0.049	-WV1-TB8	0.53 (13.5)	0.25 (6.4)	9/16 (14.3)	3700 (254)

Tribows

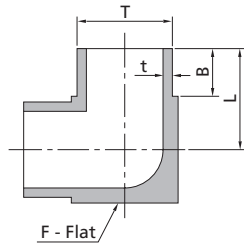

Fractional						
T-Tube O.D. (in.)	t-Wall Thickness (in.)	Basic Ordering Number	Dimensions, in. (mm)			Working Pressure psig (bar)
			L	B	F	
1/4	0.035	-WB1-TB4	0.41 (10.3)	0.25 (6.4)	5/16 (7.9)	5100 (351)
3/8	0.035	-WB1-TB6	0.47 (11.9)	0.25 (6.4)	7/16 (11.1)	3300 (227)
1/2	0.049	-WB1-TB8	0.53 (13.5)	0.25 (6.4)	9/16 (14.3)	3700 (254)



Metric						
T-Tube O.D. (mm)	t-Wall Thickness (mm)	Basic Ordering Number	Dimensions, mm (in.)			Working Pressure bar (psig)
			L	B	F	
6	1.0	-WB1-MTB6	10.4 (0.41)	6.4 (0.25)	7.9 (5/16)	420 (6095)

Union Tees

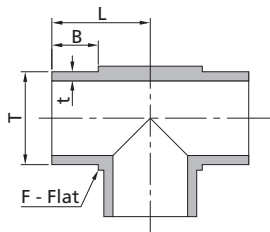

Fractional						
T-Tube O.D. (in.)	t-Wall Thickness (in.)	Basic Ordering Number	Dimensions, in. (mm)			Working Pressure psig (bar)
			L	B	F	
1/8	0.028	-WT1-TB2	0.41 (10.4)	0.25 (6.4)	5/16 (7.9)	8500 (585)
1/4	0.035	-WT1-TB4	0.41 (10.3)	0.25 (6.4)	5/16 (7.9)	5100 (351)
3/8	0.035	-WT1-TB6	0.47 (11.9)	0.25 (6.4)	7/16 (11.1)	3300 (227)
1/2	0.049	-WT1-TB8	0.53 (13.5)	0.25 (6.4)	9/16 (14.3)	3700 (254)

Metric						
T-Tube O.D. (mm)	t-Wall Thickness (mm)	Basic Ordering Number	Dimensions, mm (in.)			Working Pressure bar (psig)
			L	B	F	
6	1.0	-WT1-MTB6	10.4 (0.41)	6.4 (0.25)	7.9 (5/16)	420 (6095)
8	1.0	-WT1-MTB8	11.9 (0.47)	6.4 (0.25)	11.1 (7/16)	310 (4499)
10	1.0	-WT1-MTB10	11.9 (0.47)	6.4 (0.25)	11.1 (7/16)	240 (3483)
12	1.0	-WT1-MTB12	13.5 (0.53)	6.4 (0.25)	14.3 (9/16)	200 (2902)

Fittings

Valves

Pressure Gauges

Integrated Systems and Others

Process Specification

Extended Branch Leg Union Tees

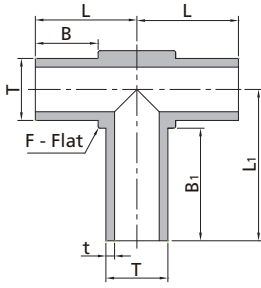

Fractional							Working Pressure psig (bar)	
T-Tube O.D. (in.)	t-Wall Thickness (in.)	Basic Ordering Number	Dimensions, in. (mm)					
			L	L ₁	B	B ₁	F	
1/4	0.035	-WT1-TB4-45	0.41 (10.4)	0.61 (15.5)	0.25 (6.4)	0.45 (11.4)	5/16 (7.9)	5100 (351)

Extended Run Leg Union Tees

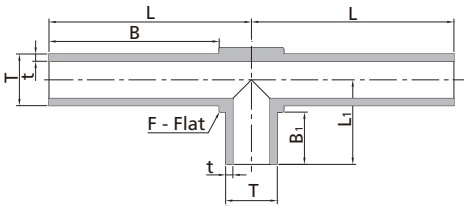

There may be a minor step between run ends at drill intersection.

Fractional							Working Pressure psig (bar)	
T-Tube O.D. (in.)	t-Wall Thickness (in.)	Basic Ordering Number	Dimensions, in. (mm)					
			L	L ₁	B	B ₁	F	
1/4	0.035	-WT1-TB4-98	0.98 (24.9)	0.41 (10.4)	0.83 (21.1)	0.25 (6.4)	5/16 (7.9)	5100 (351)

Reducing Tees

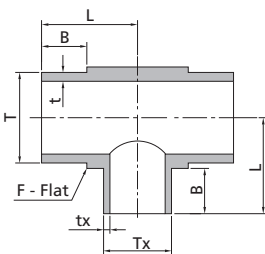

Fractional								
T-Tube O.D. (in.)	t-Wall Thickness (in.)	Tx-Tube O.D. (in.)	tx-Wall Thickness (in.)	Basic Ordering Number	Dimensions, in. (mm)			Working Pressure psig (bar)
					L	B	F	
3/8	0.035	1/4	0.035	-WT1-TB6-TB6-TB4	0.47 (11.9)	0.25 (6.4)	7/16 (11.1)	3300 (227)
1/2	0.049	1/4	0.035	-WT1-TB8-TB8-TB4	0.53 (13.5)	0.25 (6.4)	9/16 (14.3)	3700 (254)
1/2	0.049	3/8	0.035	-WT1-TB8-TB8-TB6	0.53 (13.5)	0.25 (6.4)	9/16 (14.3)	3300 (227)

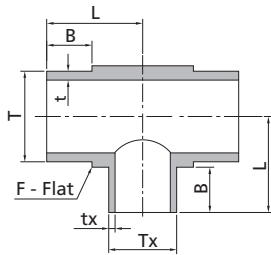

Metric				Basic Ordering Number	Dimensions, mm (in.)			Working Pressure bar (psig)
T-Tube O.D. (mm)	t-Wall Thickness (mm)	Tx-Tube O.D. (mm)	tx-Wall Thickness (mm)		L	B	F	
10	1.0	6	1.0	-WT1-MTB10-MTB10-MTB6	11.9 (0.47)	6.4 (0.25)	11.1 (7/16)	240 (3483)
12	1.0	6	1.0	-WT1-MTB12-MTB12-MTB6	0.53 (13.5)	6.4 (0.25)	14.3 (9/16)	200 (2902)
12	1.0	8	1.0	-WT1-MTB12-MTB12-MTB8	0.53 (13.5)	6.4 (0.25)	14.3 (9/16)	200 (2902)

Union Crosses

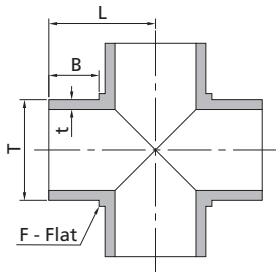

Fractional				Dimensions, in. (mm)			Working Pressure psig (bar)
T-Tube O.D. (in.)	t-Wall Thickness (in.)	Basic Ordering Number	L	B	F		
1/8	0.028	-WC1-TB2	0.41 (10.4)	0.25 (6.4)	5/16 (7.9)	8500 (585)	
1/4	0.035	-WC1-TB4	0.41 (10.3)	0.25 (6.4)	5/16 (7.9)	5100 (351)	
3/8	0.035	-WC1-TB6	0.47 (11.9)	0.25 (6.4)	7/16 (11.1)	3300 (227)	
1/2	0.049	-WC1-TB8	0.53 (13.5)	0.25 (6.4)	9/16 (14.3)	3700 (254)	

Metric				Dimensions, mm (in.)			Working Pressure bar (psig)
T-Tube O.D. (mm)	t-Wall Thickness (mm)	Basic Ordering Number	L	B	F		
6	1.0	-WC1-MTB6	10.4 (0.41)	6.4 (0.25)	7.9 (5/16)	420 (6095)	
8	1.0	-WC1-MTB8	11.9 (0.47)	6.4 (0.25)	11.1 (7/16)	310 (4499)	
10	1.0	-WC1-MTB10	11.9 (0.47)	6.4 (0.25)	11.1 (7/16)	240 (3483)	
12	1.0	-WC1-MTB12	13.5 (0.53)	6.4 (0.25)	14.3 (9/16)	200 (2902)	

Fittings

Valves

Pressure Gauges

Integrated Systems and Others

Process Specification

L Series Tube Butt Weld Fittings

Features

- Extended tube design
- Machined from forging blanks except for straight configurations
- Sizes range from 1/4" to 1" and 6 mm to 18 mm



Reducing Unions

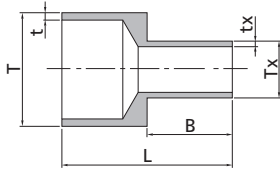

Fractional							
T-Tube O.D. (in.)	t-Wall Thickness (in.)	Tx-Tube O.D. (in.)	tx-Wall Thickness (in.)	Basic Ordering Number	Dimensions, in. (mm)		Working Pressure psig (bar)
					L	B	
3/8	0.035	1/4	0.035	-WU2-TB6-TB4	1.50 (38.1)	0.75 (19.1)	3300 (227)
1/2	0.049	1/4	0.035	-WU2-TB8-TB4	1.50 (38.1)	0.75 (19.1)	3700 (254)
1/2	0.049	3/8	0.035	-WU2-TB8-TB6	1.50 (38.1)	0.75 (19.1)	3300 (227)
3/4	0.049	1/2	0.049	-WU2-TB12-TB8	1.50 (38.1)	0.75 (19.1)	2400 (165)
1	0.065	1/2	0.049	-WU2-TB16-TB8	1.50 (38.1)	0.75 (19.1)	2400 (165)
1	0.065	3/4	0.049	-WU2-TB16-TB12	1.50 (38.1)	0.75 (19.1)	2400 (165)

Metric							
T-Tube O.D. (mm)	t-Wall Thickness (mm)	Tx-Tube O.D. (mm)	tx-Wall Thickness (mm)	Basic Ordering Number	Dimensions, mm (in.)		Working Pressure bar (psig)
					L	B	
10	1.0	6	1.0	-WU2-MTB10-MTB6	38.1 (1.50)	19.1 (0.75)	240 (3483)
10	1.0	8	1.0	-WU2-MTB10-MTB8	38.1 (1.50)	19.1 (0.75)	240 (3483)
12	1.0	6	1.0	-WU2-MTB12-MTB6	38.1 (1.50)	19.1 (0.75)	200 (2902)
12	1.0	8	1.0	-WU2-MTB12-MTB8	38.1 (1.50)	19.1 (0.75)	200 (2902)
12	1.0	10	1.0	-WU2-MTB12-MTB10	38.1 (1.50)	19.1 (0.75)	200 (2902)
18	1.5	6	1.5	-WU2-MTB18-MTB6	38.1 (1.50)	19.1 (0.75)	200 (2902)
18	1.5	12	1.5	-WU2-MTB18-MTB12	38.1 (1.50)	19.1 (0.75)	200 (2902)

90° Union Elbows

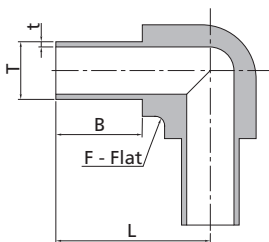

Fractional							
T-Tube O.D. (in.)	t-Wall Thickness (in.)	Basic Ordering Number	Dimensions, in. (mm)			Working Pressure psig (bar)	
			L	B	F		
1/4	0.035	-WL2-TB4	1.23 (31.2)	0.75 (19.1)	7/16 (11.1)	5100 (351)	
3/8	0.035	-WL2-TB6	1.20 (30.5)	0.75 (19.1)	7/16 (11.1)	3300 (227)	
1/2	0.049	-WL2-TB8	1.34 (34.0)	0.75 (19.1)	11/16 (17.5)	3700 (254)	
3/4	0.049	-WL2-TB12	1.46 (37.1)	0.75 (19.1)	15/16 (23.8)	2400 (165)	

Metric							
T-Tube O.D. (mm)	t-Wall Thickness (mm)	Basic Ordering Number	Dimensions, mm (in.)			Working Pressure bar (psig)	
			L	B	F		
6	1.0	-WL2-MTB6	31.2 (1.23)	19.1 (0.75)	11.1 (7/16)	420 (6095)	
8	1.0	-WL2-MTB8	31.2 (1.23)	19.1 (0.75)	11.1 (7/16)	310 (4499)	
10	1.0	-WL2-MTB10	34.0 (1.34)	19.1 (0.75)	17.5 (11/16)	240 (3483)	
12	1.0	-WL2-MTB12	34.0 (1.34)	19.1 (0.75)	17.5 (11/16)	200 (2902)	
18	1.5	-WL2-MTB18	37.6 (1.48)	19.1 (0.75)	23.8 (15/16)	200 (2902)	

Union Tees

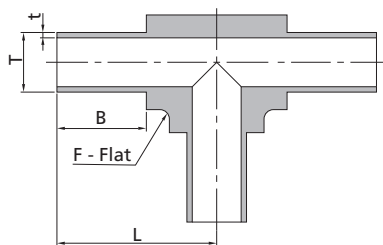

Fractional						
T-Tube O.D. (in.)	t-Wall Thickness (in.)	Basic Ordering Number	Dimensions, in. (mm)			Working Pressure psig (bar)
			L	B	F	
1/4	0.035	-WT2-TB4	1.23 (31.2)	0.75 (19.1)	7/16 (11.1)	5100 (351)
3/8	0.035	-WT2-TB6	1.20 (30.5)	0.75 (19.1)	7/16 (11.1)	3300 (227)
1/2	0.049	-WT2-TB8	1.34 (34.0)	0.75 (19.1)	11/16 (17.5)	3700 (254)
3/4	0.049	-WT2-TB12	1.46 (37.1)	0.75 (19.1)	15/16 (23.8)	2400 (165)

Metric						
T-Tube O.D. (mm)	t-Wall Thickness (mm)	Basic Ordering Number	Dimensions, mm (in.)			Working Pressure bar (psig)
			L	B	F	
6	1.0	-WT2-MTB6	31.2 (1.23)	19.1 (0.75)	11.1 (7/16)	420 (6095)
8	1.0	-WT2-MTB8	31.2 (1.23)	19.1 (0.75)	11.1 (7/16)	310 (4499)
10	1.0	-WT2-MTB10	34.0 (1.34)	19.1 (0.75)	17.5 (11/16)	240 (3483)
12	1.0	-WT2-MTB12	34.0 (1.34)	19.1 (0.75)	17.5 (11/16)	200 (2902)
18	1.5	-WT2-MTB18	37.6 (1.48)	19.1 (0.75)	23.8 (15/16)	200 (2902)

Reducing Tees

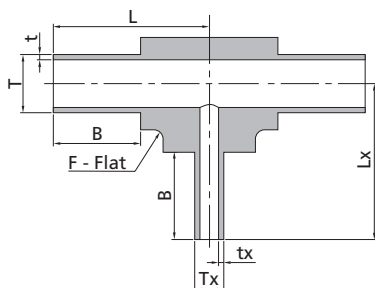

Fractional									
T-Tube O.D. (in.)	t-Wall Thickness (in.)	Tx-Tube O.D. (in.)	tx-Wall Thickness (in.)	Basic Ordering Number	Dimensions, in. (mm)			Working Pressure psig (bar)	
					L	Lx	B		F
3/8	0.035	1/4	0.035	-WT2-TB6-TB6-TB4	1.20 (30.5)	1.23 (31.2)	0.75 (19.1)	7/16 (11.1)	3300 (227)
1/2	0.049	1/4	0.035	-WT2-TB8-TB8-TB4	1.34 (34.0)	1.34 (34.0)	0.75 (19.1)	11/16 (17.5)	3700 (254)
1/2	0.049	3/8	0.035	-WT2-TB8-TB8-TB6	1.34 (34.0)	1.35 (34.3)	0.75 (19.1)	11/16 (17.5)	3700 (254)
3/4	0.049	1/4	0.035	-WT2-TB12-TB12-TB4	1.46 (37.1)	1.48 (37.6)	0.75 (19.1)	15/16 (23.8)	2400 (165)
3/4	0.049	3/8	0.035	-WT2-TB12-TB12-TB6	1.46 (37.1)	1.35 (34.3)	0.75 (19.1)	15/16 (23.8)	2400 (165)

Metric									
T-Tube O.D. (mm)	t-Wall Thickness (mm)	Tx-Tube O.D. (mm)	tx-Wall Thickness (mm)	Basic Ordering Number	Dimensions, mm (in.)			Working Pressure bar (psig)	
					L	Lx	B		F
8	1.0	6	1.0	-WT2-MTB8-MTB8-MTB6	31.3 (1.23)	31.3 (1.23)	19.1 (0.75)	11.1 (7/16)	310 (4499)
10	1.0	6	1.0	-WT2-MTB10-MTB10-MTB6	34.0 (1.34)	34.0 (1.34)	19.1 (0.75)	17.5 (11/16)	240 (3483)
10	1.0	8	1.0	-WT2-MTB10-MTB10-MTB8	34.0 (1.34)	34.0 (1.34)	19.1 (0.75)	17.5 (11/16)	240 (3483)
12	1.0	6	1.0	-WT2-MTB12-MTB12-MTB6	34.0 (1.34)	34.0 (1.34)	19.1 (0.75)	17.5 (11/16)	200 (2902)
12	1.0	8	1.0	-WT2-MTB12-MTB12-MTB8	34.0 (1.34)	34.0 (1.34)	19.1 (0.75)	17.5 (11/16)	200 (2902)

Fittings

Valves

Pressure Gauges

Integrated Systems and Others

Process Specification

Union Crosses

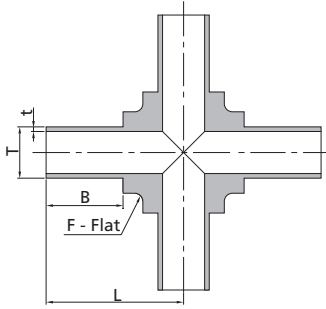

Fractional						
T-Tube O.D. (in.)	t-Wall Thickness (in.)	Basic Ordering Number	Dimensions, in. (mm)			Working Pressure psig (bar)
			L	B	F	
1/4	0.035	-WC2-TB4	1.23 (31.2)	0.75 (19.1)	7/16 (11.1)	5100 (351)
3/8	0.035	-WC2-TB6	1.20 (30.5)	0.75 (19.1)	7/16 (11.1)	3300 (227)
1/2	0.049	-WC2-TB8	1.34 (34.0)	0.75 (19.1)	11/16 (17.5)	3700 (254)

Metric						
T-Tube O.D. (mm)	t-Wall Thickness (mm)	Basic Ordering Number	Dimensions, mm (in.)			Working Pressure bar (psig)
			L	B	F	
6	1.0	-WC2-MTB6	31.2 (1.23)	19.1 (0.75)	11.1 (7/16)	420 (6095)
8	1.0	-WC2-MTB8	31.2 (1.23)	19.1 (0.75)	11.1 (7/16)	310 (4499)
10	1.0	-WC2-MTB10	34.0 (1.34)	19.1 (0.75)	15.9 (5/8)	240 (3483)
12	1.0	-WC2-MTB12	34.0 (1.34)	19.1 (0.75)	15.9 (5/8)	200 (2902)

Weld Rings

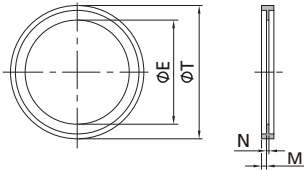

Fractional					
T-Tube O.D. (in.)	Basic Ordering Number	Dimensions, in. (mm)			
		E	M	N	T
1/4	-WR-4	0.20 (5.1)	0.02 (0.51)	0.01 (0.25)	0.28 (7.1)
3/8	-WR-6	0.32 (8.1)	0.02 (0.51)	0.01 (0.25)	0.41 (10.4)
1/2	-WR-8	0.42 (10.7)	0.02 (0.51)	0.01 (0.25)	0.54 (13.7)

Fittings

Valves

Pressure Gauges

Integrated Systems and Others

Process Specification

T Series Tubular Fittings

Features

- ◎ 316L Stainless Steel
- ◎ Sizes range from 1/4" to 2"
- ◎ Available in a variety of configurations
- ◎ All seamless tubing



Concentric Reducings

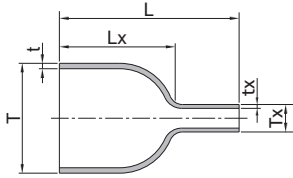

Fractional							
T-Tube O.D. (in.)	t-Wall Thickness (in.)	Tx-Tube O.D. (in.)	tx-Wall Thickness (in.)	Ordering Number	Dimensions, in. (mm)		Working Pressure psig (bar)
					L	Lx	
3/4	0.065	1/4	0.035	6L-WU3-TB12-TB4	2.13 (54.0)	0.75 (19.1)	3330 (230)
3/4	0.065	3/8	0.035	6L-WU3-TB12-TB6	2.13 (54.0)	0.75 (19.1)	3330 (230)
3/4	0.065	1/2	0.049	6L-WU3-TB12-TB8	2.13 (54.0)	0.75 (19.1)	3330 (230)
1	0.065	1/4	0.035	6L-WU3-TB16-TB4	2.36 (60.0)	1.00 (25.4)	2420 (167)
1	0.065	3/8	0.035	6L-WU3-TB16-TB6	2.36 (60.0)	1.00 (25.4)	2420 (167)
1	0.065	1/2	0.049	6L-WU3-TB16-TB8	2.36 (60.0)	1.00 (25.4)	2420 (167)
1	0.065	3/4	0.065	6L-WU3-TB16-TB12	2.64 (67.0)	1.00 (25.4)	2420 (167)
1 1/2	0.065	1/4	0.035	6L-WU3-TB24-TB4	2.87 (73.0)	1.50 (38.1)	1550 (107)
1 1/2	0.065	3/8	0.035	6L-WU3-TB24-TB6	2.87 (73.0)	1.50 (38.1)	1550 (107)
1 1/2	0.065	1/2	0.049	6L-WU3-TB24-TB8	2.87 (73.0)	1.50 (38.1)	1550 (107)
1 1/2	0.065	3/4	0.065	6L-WU3-TB24-TB12	3.15 (80.0)	1.50 (38.1)	1550 (107)
1 1/2	0.065	1	0.065	6L-WU3-TB24-TB16	3.15 (80.0)	1.50 (38.1)	1160 (80)
2	0.065	1/4	0.035	6L-WU3-TB32-TB4	2.87 (73.0)	1.50 (38.1)	1160 (80)
2	0.065	3/8	0.035	6L-WU3-TB32-TB6	2.87 (73.0)	1.50 (38.1)	1160 (80)
2	0.065	1/2	0.049	6L-WU3-TB32-TB8	2.87 (73.0)	1.50 (38.1)	1160 (80)
2	0.065	3/4	0.065	6L-WU3-TB32-TB12	3.15 (80.0)	1.50 (38.1)	1160 (80)
2	0.065	1	0.065	6L-WU3-TB32-TB16	3.15 (80.0)	1.50 (38.1)	1160 (80)
2	0.065	1 1/2	0.065	6L-WU3-TB32-TB24	3.54 (90.0)	1.50 (38.1)	1160 (80)

90° Elbows

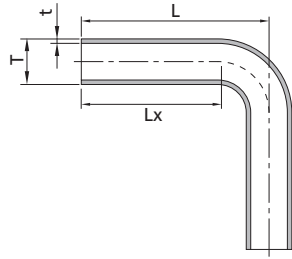

Fractional					
T-Tube O.D. (in.)	t-Wall Thickness (in.)	Ordering Number	Dimensions, in. (mm)		Working Pressure psig (bar)
			L	Lx	
1/4	0.035	6L-WL3-TB4	1.93 (49.0)	1.14 (29.0)	5150 (355)
3/8	0.035	6L-WL3-TB6	2.05 (52.0)	1.14 (29.0)	3330 (230)
1/2	0.049	6L-WL3-TB8	2.13 (54.0)	1.14 (29.0)	3530 (243)
3/4	0.065	6L-WL3-TB12	2.60 (66.0)	1.42 (36.0)	3330 (230)
1	0.065	6L-WL3-TB16	2.72 (69.0)	1.42 (36.0)	2420 (167)
1 1/2	0.065	6L-WL3-TB24	4.09 (104.0)	1.81 (46.0)	1550 (107)
2	0.065	6L-WL3-TB32	4.84 (123.0)	1.81 (46.0)	1160 (80)

45° Elbows

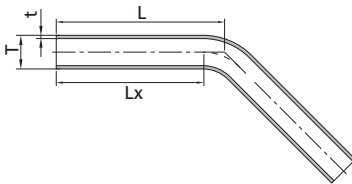

Fractional					
T-Tube O.D. (in.)	t-Wall Thickness (in.)	Ordering Number	Dimensions, in. (mm)		Working Pressure psig (bar)
			L	Lx	
1/4	0.035	6L-WV3-TB4	1.50 (38.0)	1.14 (29.0)	5150 (355)
3/8	0.035	6L-WV3-TB6	1.54 (39.0)	1.14 (29.0)	3330 (230)
1/2	0.049	6L-WV3-TB8	1.57 (40.0)	1.14 (29.0)	3530 (243)
3/4	0.065	6L-WV3-TB12	1.93 (49.0)	1.42 (36.0)	3330 (230)
1	0.065	6L-WV3-TB16	1.97 (50.0)	1.42 (36.0)	2420 (167)
1 1/2	0.065	6L-WV3-TB24	2.76 (70.0)	1.81 (46.0)	1550 (107)
2	0.065	6L-WV3-TB32	3.07 (78.0)	1.81 (46.0)	1160 (80)

Tees

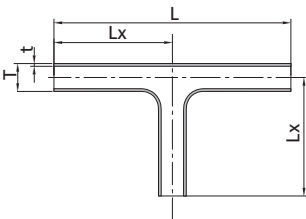

Fractional					
T-Tube O.D. (in.)	t-Wall Thickness (in.)	Ordering Number	Dimensions, in. (mm)		Working Pressure psig (bar)
			L	Lx	
1/4	0.035	6L-WT3-TB4	2.76 (70.0)	1.38 (35.0)	5150 (355)
3/8	0.035	6L-WT3-TB6	2.91 (74.0)	1.46 (37.0)	3330 (230)
1/2	0.049	6L-WT3-TB8	3.07 (78.0)	1.54 (39.0)	3530 (243)
3/4	0.065	6L-WT3-TB12	4.09 (104.0)	2.05 (52.0)	3330 (230)
1	0.065	6L-WT3-TB16	4.33 (110.0)	2.17 (55.0)	2420 (167)
1 1/2	0.065	6L-WT3-TB24	5.83 (148.0)	2.91 (74.0)	1550 (107)
2	0.065	6L-WT3-TB32	6.06 (154.0)	3.03 (77.0)	1160 (80)

Fittings

Valves

Pressure Gauges

Integrated Systems and Others

Process Specification

Reducing Tees

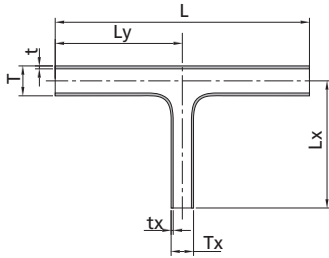

Fractional									
T-Tube O.D. (in.)	t-Wall Thickness (in.)	Tx-Tube O.D. (in.)	tx-Wall Thickness (in.)	Ordering Number	Dimensions, in. (mm)			Working Pressure psig (bar)	
					L	Lx	Ly		
3/8	0.035	1/4	0.035	6L-WT3-TB6-TB6-TB4	2.91 (74.0)	1.46 (37.0)	1.46 (37.0)	3330 (230)	
1/2	0.049	1/4	0.035	6L-WT3-TB8-TB8-TB4	3.07 (78.0)	1.54 (39.0)	1.54 (39.0)	3530 (243)	
1/2	0.049	3/8	0.035	6L-WT3-TB8-TB8-TB6	3.07 (78.0)	1.54 (39.0)	1.54 (39.0)	3330 (230)	
3/4	0.065	1/4	0.035	6L-WT3-TB12-TB12-TB4	3.70 (94.0)	1.73 (44.0)	1.85 (47.0)	3330 (230)	
3/4	0.065	3/8	0.035	6L-WT3-TB12-TB12-TB6	3.70 (94.0)	1.73 (44.0)	1.85 (47.0)	3330 (230)	
3/4	0.065	1/2	0.049	6L-WT3-TB12-TB12-TB8	3.70 (94.0)	1.73 (44.0)	1.85 (47.0)	3330 (230)	
1	0.065	1/4	0.035	6L-WT3-TB16-TB16-TB4	3.70 (94.0)	1.85 (47.0)	1.85 (47.0)	2420 (167)	
1	0.065	3/8	0.035	6L-WT3-TB16-TB16-TB6	3.70 (94.0)	1.85 (47.0)	1.85 (47.0)	2420 (167)	
1	0.065	1/2	0.049	6L-WT3-TB16-TB16-TB8	3.70 (94.0)	1.85 (47.0)	1.85 (47.0)	2420 (167)	
1	0.065	3/4	0.065	6L-WT3-TB16-TB16-TB12	4.33 (110.0)	2.17 (55.0)	2.17 (55.0)	2420 (167)	
1 1/2	0.065	1/4	0.035	6L-WT3-TB24-TB24-TB4	4.49 (114.0)	2.13 (54.0)	2.24 (57.0)	1550 (107)	
1 1/2	0.065	3/8	0.035	6L-WT3-TB24-TB24-TB6	4.49 (114.0)	2.13 (54.0)	2.24 (57.0)	1550 (107)	
1 1/2	0.065	1/2	0.049	6L-WT3-TB24-TB24-TB8	4.49 (114.0)	2.13 (54.0)	2.24 (57.0)	1550 (107)	
1 1/2	0.065	3/4	0.065	6L-WT3-TB24-TB24-TB12	5.35 (136.0)	2.44 (62.0)	2.68 (68.0)	1550 (107)	
1 1/2	0.065	1	0.065	6L-WT3-TB24-TB24-TB16	5.35 (136.0)	2.44 (62.0)	2.68 (68.0)	1550 (107)	
2	0.065	1/4	0.035	6L-WT3-TB32-TB32-TB4	4.49 (114.0)	2.24 (57.0)	2.24 (57.0)	1160 (80)	
2	0.065	3/8	0.035	6L-WT3-TB32-TB32-TB6	4.49 (114.0)	2.24 (57.0)	2.24 (57.0)	1160 (80)	
2	0.065	1/2	0.049	6L-WT3-TB32-TB32-TB8	4.49 (114.0)	2.24 (57.0)	2.24 (57.0)	1160 (80)	
2	0.065	3/4	0.065	6L-WT3-TB32-TB32-TB12	5.35 (136.0)	2.56 (65.0)	2.68 (68.0)	1160 (80)	
2	0.065	1	0.065	6L-WT3-TB32-TB32-TB16	5.35 (136.0)	2.56 (65.0)	2.68 (68.0)	1160 (80)	
2	0.065	1 1/2	0.065	6L-WT3-TB32-TB32-TB24	6.06 (154.0)	3.03 (77.0)	3.03 (77.0)	1160 (80)	

End Caps

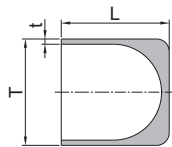

Fractional				
T-Tube O.D. (in.)	t-Wall Thickness (in.)	Ordering Number	Dimension, in. (mm)	Working Pressure psig (bar)
			L	
1/4	0.035	6L-CW3-TB4	0.50 (12.7)	5150 (355)
3/8	0.035	6L-CW3-TB6	0.50 (12.7)	3330 (230)
1/2	0.049	6L-CW3-TB8	0.50 (12.7)	3530 (243)
3/4	0.065	6L-CW3-TB12	0.75 (19.1)	3330 (230)
1	0.065	6L-CW3-TB16	1.00 (25.4)	2420 (167)
1 1/2	0.065	6L-CW3-TB24	1.50 (38.1)	1550 (107)
2	0.065	6L-CW3-TB32	1.50 (38.1)	1160 (80)

Fittings

Valves

Pressure Gauges

Integrated Systems and Others

Process Specification